

1.2 ÜRÜN BİLGİ SAYFASI

DATASHEET

SPLITMAX

SPLITMAX-LİNEER LED AYDINLATMA ARMATÜRÜ SPLITMAX - LINEAR LED LIGHTING FIXTURE

İŞIK AÇILARI / BEAL & FIELD ANGLES



ÖLÇÜLER / DIMENSIONS

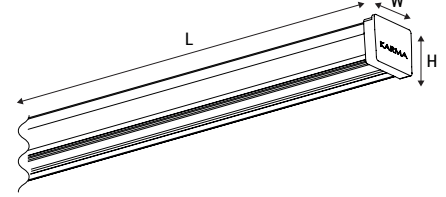

*HI1,HI3 acil kit opsiyonu bulunmaktadır. / There is an HI1,HI3 emergency kit option.

Ürün Kodu / Product Code	Güç / Power (W)	Verim / Efficiency (Lm/W)	Işık Akısı / Luminous Flux (Lm)	Enerji Etiketi / Energy Label	Ürün Ölçü (B,E,Y) / Dimension (L,W,H)	Ürün Ağırlık / Product W. (Kg)	Paket Ölçü (B,E,Y) / Product S. (L,W,H)	Paket Ağırlık / Package W. (Kg)
Gold								
35-46019-C933-G	19 W	161 Lm/W	3.059 Lm	B	1410x38x32 mm	0,8 Kg	1530x190x100 mm	12,8 Kg (16ad/16pcs.)
35-46022-C933-G	22 W	159 Lm/W	3.498 Lm	B	1410x38x32 mm	0,8 Kg	1530x190x100 mm	12,8 Kg (16ad/16pcs.)
35-46027-C933-G	27 W	158 Lm/W	4.266 Lm	B	1410x38x32 mm	0,8 Kg	1530x190x100 mm	12,8 Kg (16ad/16pcs.)
35-46035-C933-G	35 W	145 Lm/W	5.075 Lm	C	1410x38x32 mm	0,8 Kg	1530x190x100 mm	12,8 Kg (16ad/16pcs.)
Ara gövde - Boşluk / Spereta body - HopTrunk								
35-46619-S					Optional (50cm/min)x38x55 mm	0,40Kg/m		8,8Kg (22ad/22pcs.)

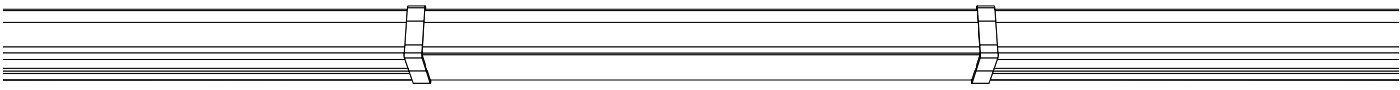

*Gövde / Body Trunking.

*Ara Gövde / Spereta Body-Hop Trunking

35 - 46XXX - CXX-[S-G] - HXX

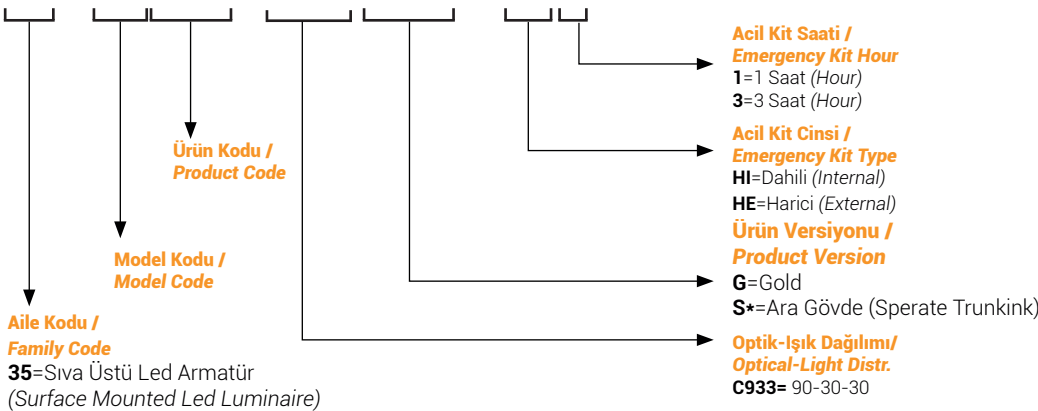

OPTİK ÖZELLİKLER / OPTICAL PROPERTIES

Renk Sıcaklığı / Color Temperature (CCT)	3000-4000-6000K
Işıma Açısı / Beam Angle	C30°-30°-30°
Renk Geri Verim İndeksi / Color Rendering Index (CRI)	>80
Difüzör / Diffuser	Şeffaf Akriolik PMMA - Lens / Clear Acrylic PMMA - Lens
Standart Sapma Renk Eşleşmesi / SDCM	MacAdam 3
Sürücü / Driver	Dahili Sürücü / Internal Drive

ELEKTRİKSEL ÖZELLİKLER / ELECTRICAL PROPERTIES

Giriş Voltajı, Frekans / Input Voltage, Frequency	100~240 AC/V 50~60 Hz
Lamba Tipi / Lamp Type	LED Module / LED Module
Güç Faktörü (PFλ) / Power Factor	>95
Acil Aydınlatma / Emergency Lighting	Gövde İçi Dahili veya Harici 1-3 Saat Bataryalı Acil Kit (Opsiyonel)/ Body Internal & External 1-3 Hours Battery Emergency Kit (Optional)
Acil Aydınlatma Gücü / Emergency Lighting Power	+%10-15
IEC Koruma Sınıfı (Armatür) / IEC Protection Class (Armature)	CLASS (I)
Otomasyon / Automation	Şebeke Girişi Pano veya Harici Kontrol Modülleri ile Kontrol Edilebilir / Mains Input can be Controlled by Panel or External Control Modules

MEKANİK ÖZELLİKLER / MECHANICAL PROPERTIES

Montaj Seçenekleri / Mounting Options	Paslanmaz Yay Çelik Tavan Bağlantısı veya İstenilen Uzunlukta Sarkıtma / Stainless Arrow Steel Ceiling Mount or Suspended in Desired Length
IP - Koruma sınıfı / IP - Protection Class	IP44
Montaj Tipi / Mounting Type	Sıva Üstü, Sarkıt / Surface Mounted, Pendant
Montaj Yeri / Mounting Location	Tavan/ Ceiling
Şebeke Bağlantısı / Network Connection	Faz, Nötr, Toprak Bağlantı (Opsiyonel: 2 Hat, 3 Hat, 4 Hat)/ Phase, Neutral, Ground Connection (Optional: 2 Lines, 3 Lines, 4 Lines)
Uygulama Yüksekliği / Application Height	2.4m-4m

SICAKLIK VE ÇALIŞMA KOŞULLARI / TEMPERATURES AND OPERATING CONDITIONS

Çalışma Isısı (Oda Sıcaklığında) / Working Temperature	-20°C ...+50°C
--	----------------

DEPOLAMA BİLGİLERİ / STORAGE INFORMATION

Depolamada Sıcaklık Aralığı / Temperature Range at Storage	-30°C...+70°C
--	---------------

RENKLER & MATERYAL / COLORS & MATERIAL

Gövde Malzemesi / Body Material	Alüminyum Ekstrüzyon Profil / Aluminum Extrusion Profile
Gövde Rengi Seçenekleri / Body Color Options	Siyah (RAL:9005), Beyaz (RAL:9016), Metal-Gri (RAL:9006), Antrasit (RAL:7043) / Black (RAL:9005), White (RAL:9016), Metal-Gray (RAL:9006), Anthracite (RAL:7043)
Ürün Boyası / Product Paint	Elektrostatik Toz Boya / Electrostatic Powder Coating

ÜRÜNÜN YAŞAM SÜRESİ / PRODUCT LIFE TIME

Anahtarlama Döngü Sayısı / Number of Switching Cycles	500.000
Ömür / Lifespan L80/B50 at 25 C°	54.000 h

SERTİFİKALAR & STANDARTLAR / CERTIFICATES & STANDARDS

Koruma Sınıfı IK (Şok Direnci) / Protection Class IK (Shock Resistance)	IK 03
Sertifikasyon / Certification	ISO 9001, LVD, EMC, CE, RoHS EN 60598-1, EN 60598-2-1, EN 55015, EN 61547 EU EcoDesign Compliant (EEC) - 2019/2020 EU

EU EcoDesign Compliant (EEC) - 2019/2020 EU

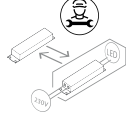

Bir profesyonel tarafından
değiştirilebilir kontrol tertibatı
Replaceable control gear
by a professional

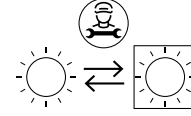

Bir profesyonel tarafından
değiştirilebilir ışık kaynağı
Replaceable light
source by a professional

EKİPMAN & AKSESUARLAR / EQUIPMENT & ACCESSORIES



Vidalı Tavan Bağlantı Klipsi
Screw ceiling mount clip

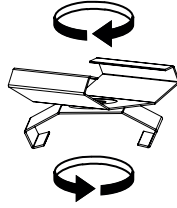

Hareketli montaj klipsi
Rotatable mounting clip



Askı Teli
Suspended Wire

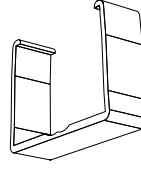

Derz Örtücü
Joint Cover

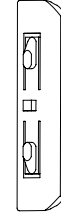

Ara Köprü
Intermediate Bridge

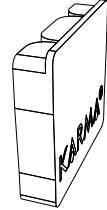

Uç Kapak
End Cap

OPSİYONLAR / OPTIONS

	Askı Teli Suspended Wire	Paslanmaz yay çeliğinden üretilir. Vidalama veya askı için uygundur. Maks. yük taşıma 9kg'dır. (detaylar için montaj klavuzuna gözetin) It is produced from Stainless spring steel. Suitable for screwing or hanging. Max. load carrying is 9kg. (see assembly manual for details)
	Tavan Bağlantı Klipsi (Tekli) Ceiling Fastening Clip (Single)	Paslanmaz yay çeliği malzemeden üretilir. Armatürlerin monyaj yüzeyine kolayca montajını sağlar. It is produced from stainless spring steel material. It allows the fixtures to be easily mounted on the mounting surface.
	Tavan Bağlantı Klipsi (Çiftli) / Ceiling Fastening Clip (Double)	Paslanmaz yay çeliği malzemeden üretilir. Armatürlerin monyaj yüzeyine kolayca montajını sağlar ve 360° dönebilir. (detaylar için montaj klavuzuna gözetin) It is produced from stainless spring steel material. Fix the fixtures to the mounting surface It provides easy assembly and can rotate 360°. (see assembly manual for details)



** Bu ekipmanlar ile nasıl montaj yapılacağını "**Montaj Kılavuzu**" belgesine inceleyerek görebilirsiniz
** See how to assemble with these equipment by examining the "**Installation Manual**" document.



** Semboller ve ifadeleri için "Sembol/piktogram" tablosuna bakın.
** See the "Symbol/pictogram" table for symbols and their meanings.

TESTLER / TESTS

Işık Dağılımı/ Light Distribution

Işık Yayımları 1 - Polar LVK Light Light Emission 1 - Polar LVK

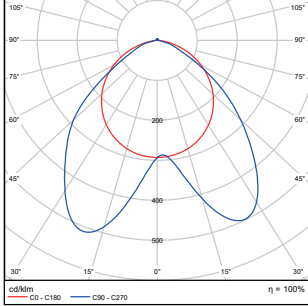

Işık Yayımları 1 - Linear LVK Light emission 1 - Polar LVK

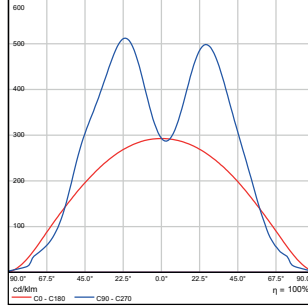

Işık Yayımları 1 - Işıklık Diagramı Light emission 1 - Skylight Diagram

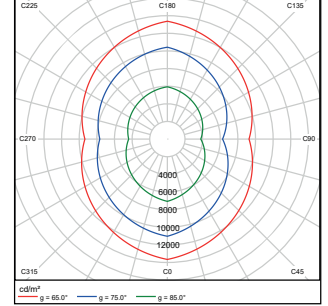

Uzaktaki Parlaklık (Işın Açısı) / Illuminance at a Distance (Beam Angle)

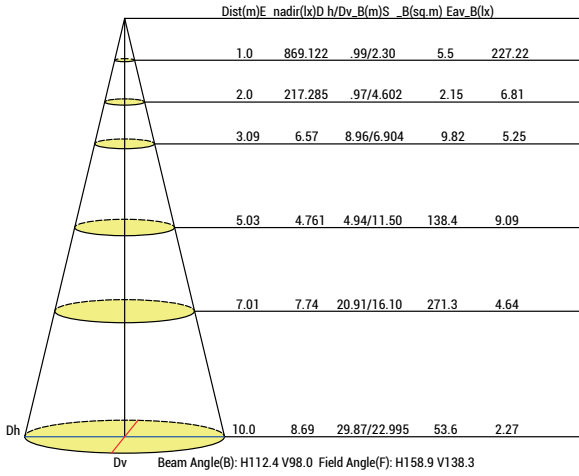

Uzaktaki Parlaklık (Alan Açısı) / Illuminance at a Distance (Field Angle)

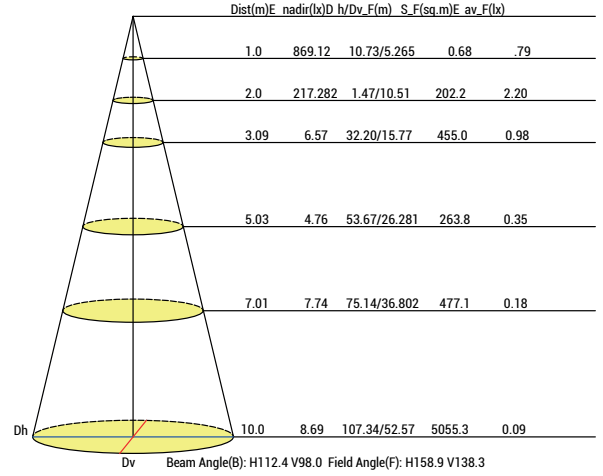

Ortalama Aydınlık Etkili Şekil / The Average Illuminance Effective Figure

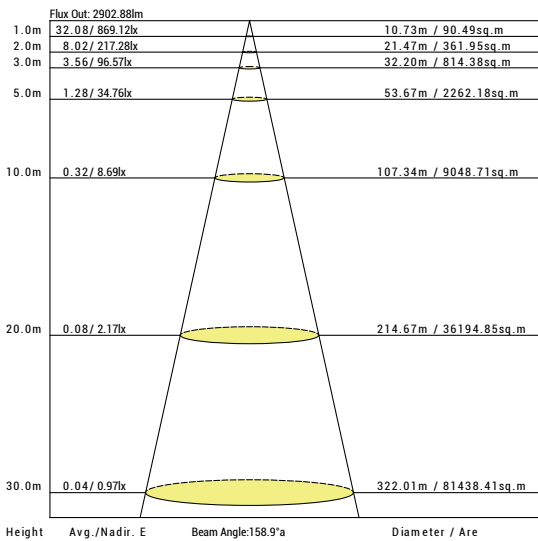

Dikey IsoLux Grafiği / Vertical IsoLux Plot

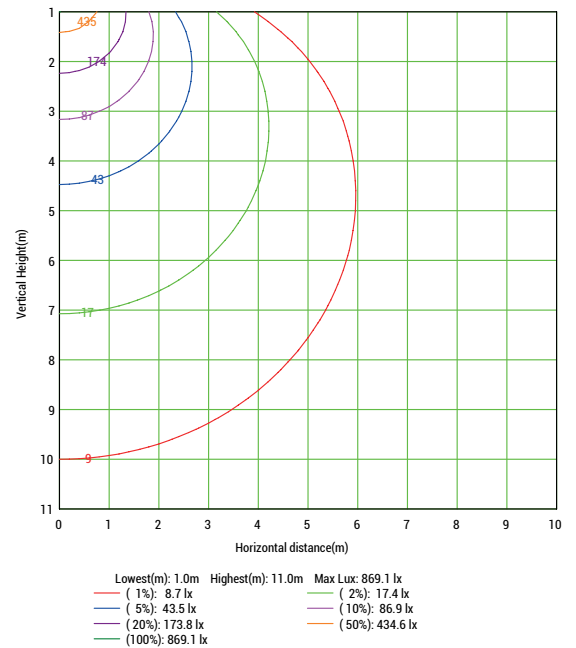

*SPLITMAX 35-46022-C933-G ürünün ölçümleridir./ *The measurements of the SPLITMAX 35-46022-C933-G product.

ÜRÜN FOTOĞRAFLARI / PRODUCT PHOTOS

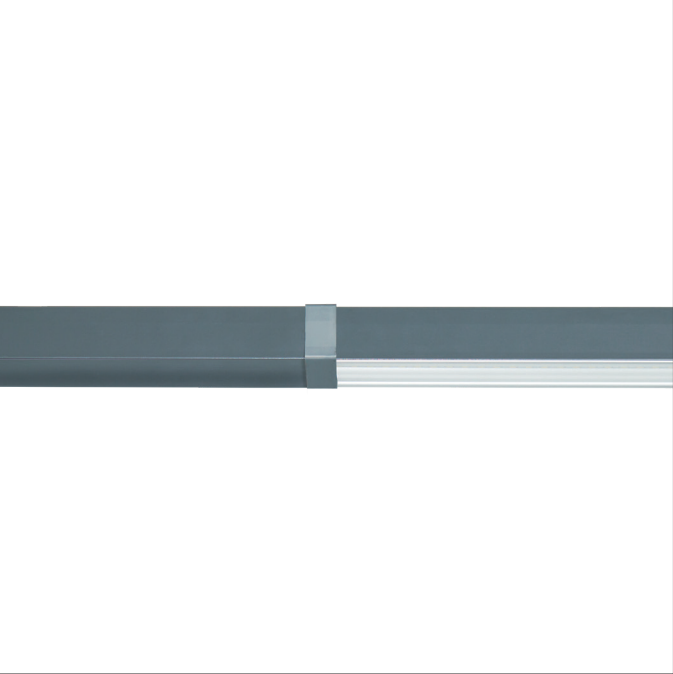
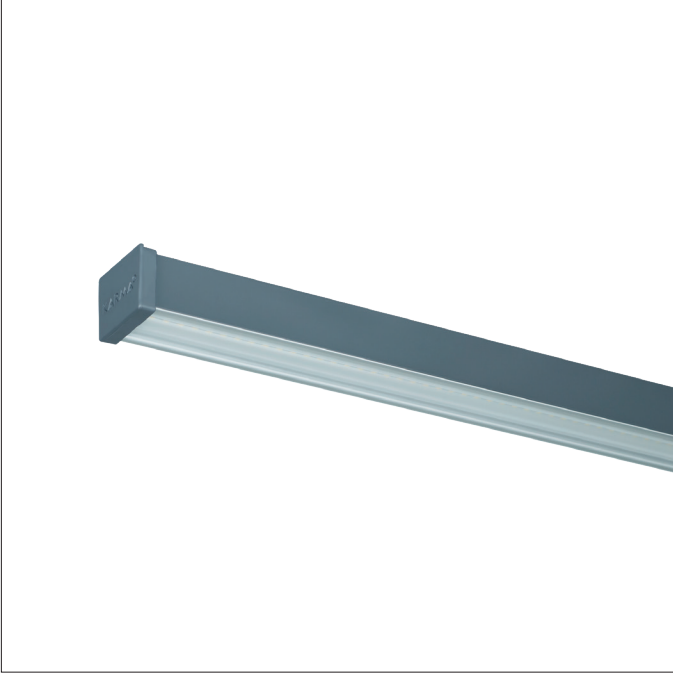

REFERANSLAR & LİNKLER / REFERENCES & LINKS



www.karmalighting.com



KARMA Lighting



karma.lighting



KarmaLighting



karma.lighting.global



Karma LED Lighting