

## 1.2 ÜRÜN BİLGİ SAYFASI

### DATASHEET

# MAXLINE

**MAXLINE-LİNEER LED PROFİL AYDINLATMA ARMATÜRÜ (Taşıyıcı sistem)**  
MAXLINE - LINEAR LED PROFILE LIGHTING FIXTURE (Trunking system)

### ÖLÇÜLER / DIMENSIONS

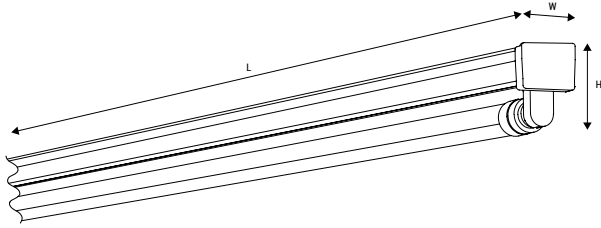

\*HE1,HE3,HI1 acil kit opsiyonu bulunmaktadır. / There is an HE1,HE3,HI1 emergency kit options.

Ürün Kodu / Product Code	Lamba Ad. - Lamba Tipi / Bulb qty - Bulb Type (PC/S)	Ürün Ölçü (B,E,Y) / Dimension (L,W,H)	Ürün Ağırlık / Product Weight (Kg)	Paket Ölçü (B,E,Y) / Product S. (L,W,H)	Paket Ağırlık / Package Weight (Kg)
35-45219-S	1xT5	1172x38x55 mm	0,50Kg	1530x190x100 mm	10,0 Kg (19ad/19pcs.)
35-45219-G	1xT5	1482x38x55 mm	0,62Kg	1530x190x100 mm	12,8 Kg (19ad/19pcs.)
35-45538-G	2x(1xT5)	2964x38x55 mm	1,3Kg	3060x190x100 mm	11,4Kg (8ad/8pcs.)
<b>Ara gövde - Boşluk / Sperate body - HopTrunk</b>					
35-45522-S	Optional (50cm/min)x38x55 mm		0,40Kg/Meter	3060x190x100 mm	8,8Kg (22ad/22pcs.)

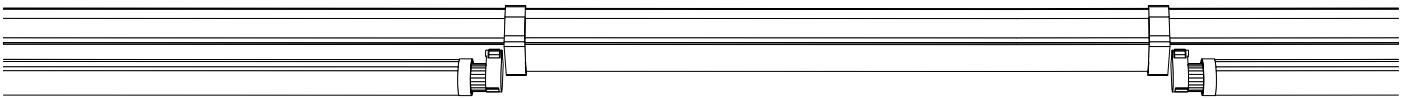

\*Lamba gövdesi. / Lamp Body Trunk.

\*Ara gövde. / Sperate Body-Hop Trunk.

## 35 - 45XXX - [S-G] - LX-HXX

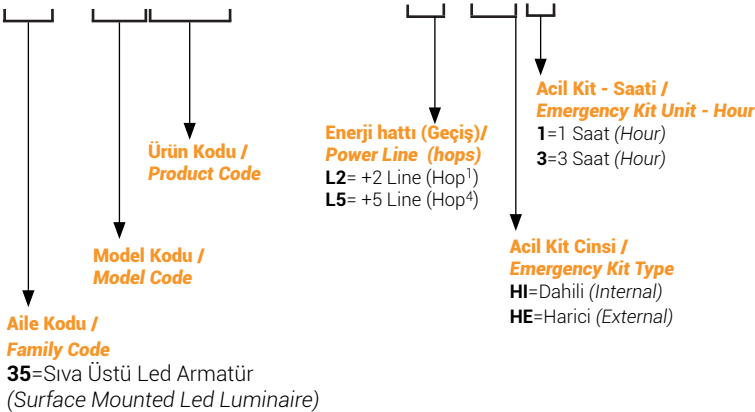

## UYUMLU LED TÜPLER / PRODUCT COMPATIBLE LED TUBES

Ürün Kodu / Product Code	Güç / Power (W)	Verim / Efficiency (Lm/W)	Işık Akısı / Luminous Flux (Lm)	Enerji Etiketi / Energy Label	Ürün Ölçü / Dimension Ø   L (mm)	Ürün Ağırlık / Product W. (Kg)	Paket Ölçü (B,E,Y) / Product S. (L,W,H)	Paket Ağırlık / Package W. (Kg)
<b>Silver</b>								
05-5315-S	15 W	145 Lm/W	2.175 Lm	C	23   1150 mm	0,22 Kg	1530x190x260 mm	13,9 Kg (63ad/63pcs.)
05-5316-S	19 W	145 Lm/W	2.755 Lm	C	23   1150 mm	0,22 Kg	1530x190x260 mm	13,9 Kg (63ad/63pcs.)
05-5317-S	22 W	143 Lm/W	3.146 Lm	C	23   1150 mm	0,22 Kg	1530x190x260 mm	13,9 Kg (63ad/63pcs.)
05-5319-S	19 W	145 Lm/W	2.755 Lm	C	23   1450 mm	0,28 Kg	1530x190x260 mm	17,6 Kg (63ad/63pcs.)
05-5322-S	22 W	142 Lm/W	3.124 Lm	C	23   1450 mm	0,28 Kg	1530x190x260 mm	17,6 Kg (63ad/63pcs.)
05-5323-S	25 W	140 Lm/W	3.500 Lm	C	23   1450 mm	0,28 Kg	1530x190x260 mm	17,6 Kg (63ad/63pcs.)
05-5324-S	27 W	138 Lm/W	3.726 Lm	C	23   1450 mm	0,28 Kg	1530x190x260 mm	17,6 Kg (63ad/63pcs.)
05-5335-S	35 W	132 Lm/W	4.620 Lm	D	23   1450 mm	0,28 Kg	1530x190x260 mm	17,6 Kg (63ad/63pcs.)
<b>Gold</b>								
05-5315-G	15 W	161 Lm/W	2.415 Lm	B	23   1150 mm	0,22 Kg	1530x190x100 mm	13,9 Kg (63ad/63pcs.)
05-5316-G	19 W	161 Lm/W	3.059 Lm	B	23   1150 mm	0,22 Kg	1530x190x100 mm	13,9 Kg (63ad/63pcs.)
05-5317-G	22 W	159 Lm/W	3.498 Lm	B	23   1150 mm	0,22 Kg	1530x190x100 mm	13,9 Kg (63ad/63pcs.)
05-5319-G	19 W	161 Lm/W	3.059 Lm	B	23   1450 mm	0,28 Kg	1530x190x100 mm	17,6 Kg (63ad/63pcs.)
05-5322-G	22 W	159 Lm/W	3.498 Lm	B	23   1450 mm	0,28 Kg	1530x190x100 mm	17,6 Kg (63ad/63pcs.)
05-5323-G	25 W	158 Lm/W	3.950 Lm	B	23   1450 mm	0,28 Kg	1530x190x100 mm	17,6 Kg (63ad/63pcs.)
05-5324-G	27 W	158 Lm/W	4.266 Lm	B	23   1450 mm	0,28 Kg	1530x190x100 mm	17,6 Kg (63ad/63pcs.)
05-5335-G	35 W	145 Lm/W	5.075 Lm	C	23   1450 mm	0,28 Kg	1530x190x100 mm	17,6 Kg (63ad/63pcs.)
<b>Platinum</b>								
05-5315-P	15 W	184 Lm/W	2.760 Lm	A	23   1150 mm	0,22 Kg	1530x190x100 mm	13,9 Kg (63ad/63pcs.)
05-5316-P	19 W	184 Lm/W	3.496 Lm	A	23   1150 mm	0,22 Kg	1530x190x100 mm	13,9 Kg (63ad/63pcs.)
05-5317-P	22 W	182 Lm/W	4.004 Lm	A	23   1150 mm	0,22 Kg	1530x190x100 mm	13,9 Kg (63ad/63pcs.)
05-5319-P	19 W	184 Lm/W	3.496 Lm	A	23   1450 mm	0,28 Kg	1530x190x100 mm	17,6 Kg (63ad/63pcs.)
05-5322-P	22 W	181 Lm/W	3.982 Lm	A	23   1450 mm	0,28 Kg	1530x190x100 mm	17,6 Kg (63ad/63pcs.)
05-5323-P	25 W	180 Lm/W	4.500 Lm	A	23   1450 mm	0,28 Kg	1530x190x100 mm	17,6 Kg (63ad/63pcs.)
05-5324-P	27 W	179 Lm/W	4.833 Lm	A	23   1450 mm	0,28 Kg	1530x190x100 mm	17,6 Kg (63ad/63pcs.)
05-5335-P	35 W	165 Lm/W	5.775 Lm	B	23   1450 mm	0,28 Kg	1530x190x100 mm	17,6 Kg (63ad/63pcs.)

\*HE1,HE3,HI1 acil kit opsiyonu bulunmaktadır. / There is an HE1,HE3,HI1 emergency kit option.



\*Daha fazla detay için LED Tüpler dökümanına bakın.  
See LED Tubes documentation for more details.

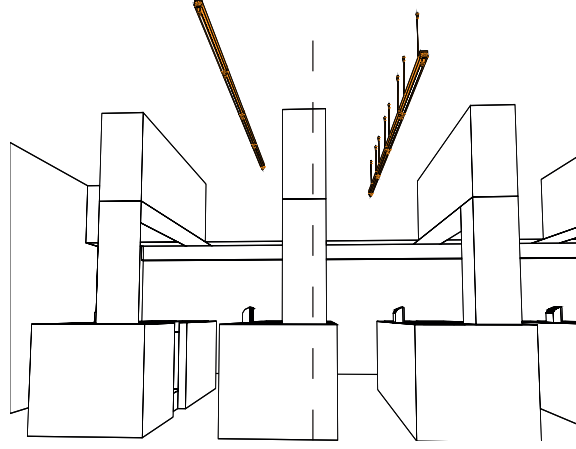

Tavan Montaj Aparatlı Montaj Modeli /  
Mounting Model with Ceiling Mounting  
Apparatus

Askı Telli Montaj Modeli /  
Suspended Wire Mounting Model

## ELEKTRİKSEL ÖZELLİKLER / ELECTRICAL PROPERTIES

Giriş Hattı / Input Lines	5 Line Hop - 1,5mm <sup>2</sup> (max)
Taşıma Kapasitesi = Uç uca Ekleme / Carrying capacity = Butt Joint pcs	0,75mm <sup>2</sup> (8A) max Hop = 20; 1,0mm <sup>2</sup> (10A) max Hop = 30; 1,5mm <sup>2</sup> (15A) max Hop = 40;
Lamba Tipi / Lamp Type	T5 LED Tüp / T5 LED Tube (G5 Pin)
Acil Aydınlatma / Emergency Lighting	1-3 Saat Bataryalı Acil Kit (Opsiyonel), / External 1-3 Hours Battery Emergency Kit (Optional)
Acil Aydınlatma Gücü / Emergency Lighting Power	3w (+%10-15)
IEC Koruma Sınıfı / IEC Protection Class	CLASS (I)
Sensör / Sensor	Harekete & Sese Duyarlı Sensör (Opsiyonel) / Motion & Sound Sensitive Sensor (Optional)
Otomasyon / Automation	Şebeke Girişi Pano veya Harici Kontrol Modülleri ile Kontrol Edilebilir / Mains Input can be Controlled by Panel or External Control Modules

## MEKANİK ÖZELLİKLER / MECHANICAL PROPERTIES

Montaj Seçenekleri / Mounting Options	Paslanmaz yay çelik tavan bağlantısı veya istenilen Uzunlukta Sarkıtma/ Stainless Arrow Steel Ceiling Mount or Suspended in Desired Length
IP - Koruma sınıfı / IP - Protection Class	IP20
Montaj Tipi / Mounting Type	Sıva Üstü, Sarkıt / Surface Mounted, Pendant
Montaj Yeri / Mounting Location	Tavan / Ceiling
Uygulama Yüksekliği / Application Height	<5m

## RENKLER & MATERYAL / COLORS & MATERIAL

Gövde Malzemesi / Body Material	Alüminyum Ekstrüzyon / Aluminum Extrusion
Gövde Rengi Seçenekleri / Body Color Options	Siyah (RAL:9005), Beyaz (RAL:9016), Metal-Gri (RAL:9006), Antrasit (RAL:7043) / Black (RAL:9005), White (RAL:9016), Metal-Gray (RAL:9006), Anthracite (RAL:7043)
Ürün Boyası / Product Paint	Elektrostatik Toz Boya / Electrostatic Powder Coating

## SERTİFİKALAR & STANDARTLAR / CERTIFICATES & STANDARDS

Koruma Sınıfı IK (Şok Direnci) / Protection Class IK (Shock Resistance)	IK 03
Sertifikasyon & Stadartlar / Certification & Standarts	ISO 9001, LVD, EMC, CE, RoHS EN 50598-2-1:1989 - EN 60598-1:2015/A:2018, EN 55015:2013:A1:2015 & EN 61547:2009 EN 61000-3-2:2014, EN 61000-3-3:2013 EN IEC 55015:2019/A11:2020, EN 61547:2009, EN IEC 61000-3-2:2019/ A1:2021 EU EcoDesign Compliant (EEC) - 2019/2020 EU

## EU EcoDesign Compliant (EEC) - 2019/2020 EU

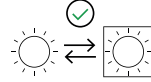

Son kullanıcı tarafından değiştirilebilir ışık kaynağı

Replaceable light source by an and-user

## EKİPMAN & AKSESUARLAR / EQUIPMENT & ACCESSORIES

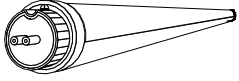

T5 LED Tüp  
T5-TL16 LED Tube

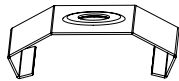

Vidalı Tavan Bağlantı Klipsi  
Screw ceiling mount clip

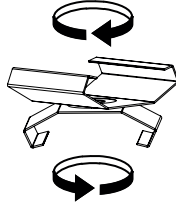

Hareketli montaj klipsi  
Rotatable mounting clip



Askı Teli  
Suspended Wire

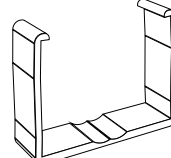

Derz Örtücü  
Joint Cover

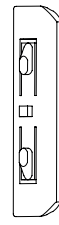

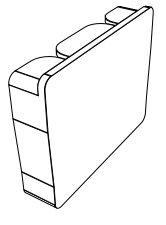

Ara Köprü  
Connection Clip



Uç Kapak  
End Cap

## OPSİYONLAR / OPTIONS

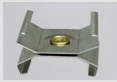
	T5 LED Tüp / T5 LED Tube	>50.000h ömür, floresana göre %80'e yakın tasarruf, hareket-ışık sensörü ve dahili 1-3 saat acil kite sahiptir. Lifespan >50.000h, savings of nearly 80% compared to fluorescent, motion-light sensor and 1-3 hours emergency kit.
	Askı Teli Suspended Wire	Paslanmaz yay çeliğinden üretilir. Vidalama veya askı için uygundur. Maks. yük taşıma 9kg'dır. (detaylar için montaj klavuzuna gözetin) It is produced from Stainless spring steel. Suitable for screwing or hanging. Max. load carrying is 9kg. (see assembly manual for details)
	Tavan Bağlantı Klipsi (Tekli) Ceiling Fastening Clip (Single)	Paslanmaz yay çeliği malzemeden üretilir. Armatürlerin monyaj yüzeyine kolayca montajını sağlar. It is produced from stainless spring steel material. It allows the fixtures to be easily mounted on the mounting surface.
	Tavan Bağlantı Klipsi (Çiftli) / Ceiling Fastening Clip (Double)	Paslanmaz yay çeliği malzemeden üretilir. Armatürlerin monyaj yüzeyine kolayca montajını sağlar ve 360° dönebilir. (detaylar için montaj klavuzuna gözetin) It is produced from stainless spring steel material. Fix the fixtures to the mounting surface It provides easy assembly and can rotate 360°. (see assembly manual for details)



\*\* Bu ekipmanlar ile nasıl montaj yapılacağını "**Montaj Kılavuzu**" belgesine inceleyerek görebilirsiniz  
\*\* See how to assemble with these equipment by examining the "**Installation Manual**" document.



\*\* Semboller ve ifadeleri için "Sembol/piktogram" tablosuna bakın.  
\*\* See the "Symbol/pictogram" table for symbols and their meanings.

## ÜRÜN FOTOĞRAFLARI / PRODUCT PHOTOS



## REFERANSLAR & LİNKLER / REFERENCES & LINKS



[www.karmalighting.com](http://www.karmalighting.com)



KARMA Lighting



karma.lighting



KarmaLighting



karma.lighting.global



Karma LED Lighting