

1.2 ÜRÜN BİLGİ SAYFASI

DATASHEET

PL 1XT5

PL-LİNEER T5 LED AYDINLATMA ARMATÜRÜ (Taşıyıcı sistem)
PL - LINEAR T5 LED LIGHTING FIXTURE (Trunking system)

ÖLÇÜLER / DIMENSIONS

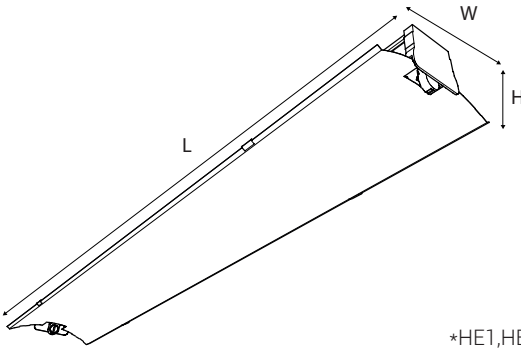

*HE1,HE3,HI1 acil kit opsiyonu bulunmaktadır. / There is an HE1,HE3,HI1 emergency kit options.

Ürün Kodu / Product Code	Lamba Ad. - Lamba Tipi/ Bulb qty - Bulb Type (PC/S)	Ürün Ölçü (B,E,Y) / Dimension (L,W,H)	Ürün Ağırlık / Product Weight. (Kg)
35-37008-G	1xT5	578x170x60 mm	0,58Kg
35-37115-G	1xT5	1175x170x60 mm	1,18 Kg
35-37119-G	1xT5	1475x170x60 mm	1,48 Kg
35-37120-G	2x(1xT5)	2950x170x60 mm	2,97 Kg

UYUMLU LED TÜPLER / PRODUCT COMPATIBLE LED TUBES



*Daha fazla detay için LED Tüpler dökümanına bakın.
See LED Tubes documentation for more details.

ÜRÜN KOD ANAHTARI / PRODUCT COMBINATION KEY

35 - 37XXX - G - LX-HXX

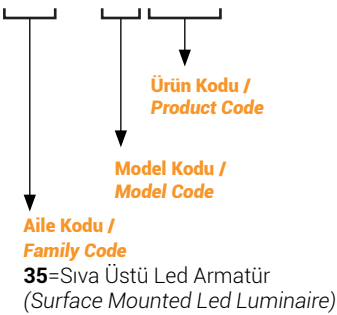

Acil Kit - Saati /
Emergency Kit Unit - Hour

1=1 Saat (Hour)
3=3 Saat (Hour)

Acil Kit Cinsi /
Emergency Kit Type

HI=Dahili (Internal)
HE=Harici (External)

Enerji hattı (Geçiş)/
Power Line (hops)

L2= +2 Line (Hop¹)
L5= +5 Line (Hop⁴)

ELEKTRİKSEL ÖZELLİKLER / ELECTRICAL PROPERTIES

Giriş Hattı / Input Lines	5 Line Hop - 1,5mm ² (max)
Taşıma Kapasitesi = Uç uca Ekleme / Carrying capacity = Butt Joint pcs	0,75mm ² (8A) max Hop = 20; 1,0mm ² (10A) max Hop = 30; 1,5mm ² (15A) max Hop = 40;
Lamba Tipi / Lamp Type	T5 LED Tüp / T5 LED Tube (G5 Pin)
Acil Aydınlatma / Emergency Lighting	1-3 Saat Bataryalı Acil Kit (Opsiyonel), / External 1-3 Hours Battery Emergency Kit (Optional)
Acil Aydınlatma Gücü / Emergency Lighting Power	3w (+%10-15)
IEC Koruma Sınıfı / IEC Protection Class	CLASS (I)
Sensör / Sensor	Harekete & Sese Duyarlı Sensör (Opsiyonel) / Motion & Sound Sensitive Sensor (Optional)
Otomasyon / Automation	Şebeke Girişi Pano veya Harici Kontrol Modülleri ile Kontrol Edilebilir / Mains Input can be Controlled by Panel or External Control Modules

MEKANİK ÖZELLİKLER / MECHANICAL PROPERTIES

Montaj Seçenekleri / Mounting Options	Paslanmaz yay çelik tavan bağlantısı veya istenilen Uzunlukta Sarkıtma/ Stainless Arrow Steel Ceiling Mount or Suspended in Desired Length
IP - Koruma sınıfı / IP - Protection Class	IP20
Montaj Tipi / Mounting Type	Sıva Üstü, Sarkıt / Surface Mounted, Pendant
Montaj Yeri / Mounting Location	Tavan / Ceiling
Uygulama Yüksekliği / Application Height	<5m

RENKLER & MATERYAL / COLORS & MATERIAL

Gövde Malzemesi / Body Material	Alüminyum Ekstrüzyon / Aluminum Extrusion
Gövde Rengi Seçenekleri / Body Color Options	Siyah (RAL:9005), Beyaz (RAL:9016), Metal-Gri (RAL:9006), Antrasit (RAL:7043) / Black (RAL:9005), White (RAL:9016), Metal-Gray (RAL:9006), Anthracite (RAL:7043)
Ürün Boyası / Product Paint	Elektrostatik Toz Boya / Electrostatic Powder Coating
Yansıtıcı / Reflektor	Anodize %99,8 yansıtma / Anodized 99.8% reflectivity

SERTİFİKALAR & STANDARTLAR / CERTIFICATES & STANDARDS

Koruma Sınıfı IK (Şok Direnci) / Protection Class IK (Shock Resistance)	IK 03
Sertifikasyon & Stadartlar / Certification & Standarts	ISO 9001, LVD, EMC, CE, RoHS EN 50598-2-1:1989 - EN 60598-12015/A:2018, EN 55015:2013:A1:2015 & EN 61547:2009 EN 61000-3-2:2014, EN 61000-3-3:2013 EN IEC 55015:2019/A11:2020, EN 61547:2009, EN IEC 61000-3-2:2019/ A1:2021 EU EcoDesign Compliant (EEC) - 2019/2020 EU

EU EcoDesign Compliant (EEC) - 2019/2020 EU

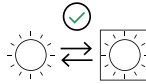

Son kullanıcı tarafından
değiştirilebilir ışık kaynağı

Replaceable light source by an
and-user

İŞIK DAĞILIMI / LIGHT DISRIBUTION

Işık Yayımı 1 - Polar LVK Light Light
Emission 1 - Polar LVK

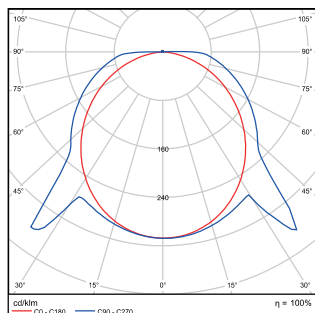

Işık Yayımı 1 - Lineer LVK
Light emission 1 - Polar LVK

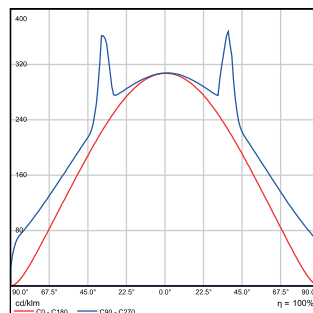

Işık Yayımı 1 - Işıklık Diagramı
Light emission 1 - Skylight Diagram

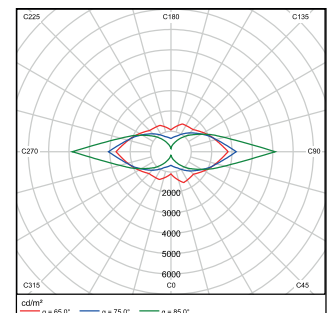

05-5319-S T5 LED Tüp ürünün ölçümleridir./ *The measurements of the 05-5319-S LED Tube product.

EKİPMAN & AKSESUARLAR / EQUIPMENT & ACCESSORIES

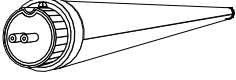

T5 LED Tüp /
T5-TL16 LED Tube

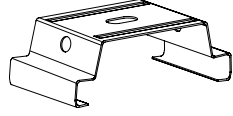

Tavan Bağlantı Klipsi-Tekli /
Ceiling Fastening Clip-Single



Askı Teli /
Suspended Wire

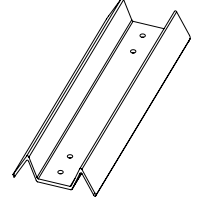

Ara Köprü /
Interconnection Bridge

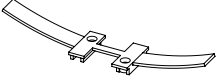

Derz Örtücü /
Joint Sealant

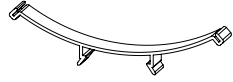

Yansıtıcı Tutucu /
Reflector Holder Cover

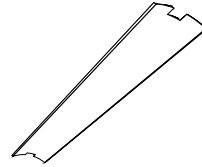

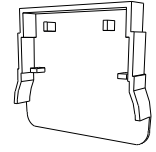

Yansıtıcı /
Reflector



Uç Kapak /
End-Cap

OPSİYONLAR / OPTIONS

	T5 LED Tüp / T5 LED Tube	>50.000h ömür, floresana göre %80'e yakın tasarruf, hareket-ışık sensörü ve dahili 1-3 saat acil kite sahiptir. Lifespan >50.000h, savings of nearly 80% compared to fluorescent, motion-light sensor and 1-3 hours emergency kit.
	Askı Teli / Suspended Wire	Paslanmaz yay çeliğinden üretilir. Vidalama veya askı için uygundur. Maks. yük taşıma 9kg'dır. (detaylar için montaj klavuzuna gözetin) It is produced from Stainless spring steel. Suitable for screwing or hanging. Max. load carrying is 9kg. (see assembly manual for details)
	Tavan Bağlantı Klipsi / Ceiling Fastening Clip	Paslanmaz yay çeliği malzemeden üretilir. Armatürlerin monyaj yüzeyine kolayca montajını sağlar. It is produced from stainless spring steel material. It allows the fixtures to be easily mounted on the mounting surface.



** Bu ekipmanlar ile nasıl montaj yapılacağını "**Montaj Kılavuzu**" belgesine inceleyerek görebilirsiniz.
** See how to assemble with these equipment by examining the "**Installation Manual**" document.



** Semboller ve ifadeleri için "Sembol/piktogram" tablosuna bakın.
** See the "Symbol/pictogram" table for symbols and their meanings.

ÜRÜN FOTOĞRAFLARI / PRODUCT PHOTOS

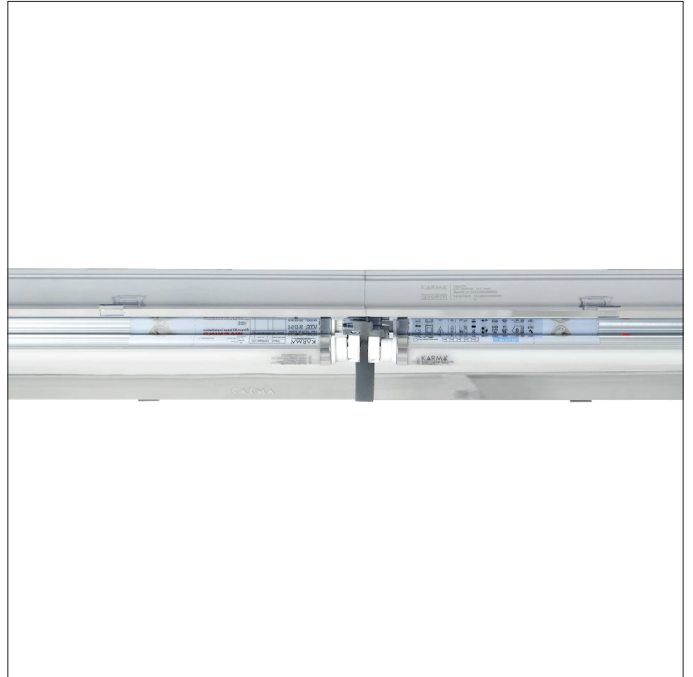

REFERANSLAR & LİNKLER / REFERENCES & LINKS



www.karmalighting.com



KARMA Lighting



KarmaLighting



karma.lighting.global



Karma LED Lighting