

1.4 MONTAJ ve KULLANIM KILAVUZU

MOUNTING and USER GUIDE

DEFIX

DEFIX-LİNEER LED AYDINLATMA ARMATÜRÜ
DEFIX - LINEAR LED LIGHTING FIXTURE

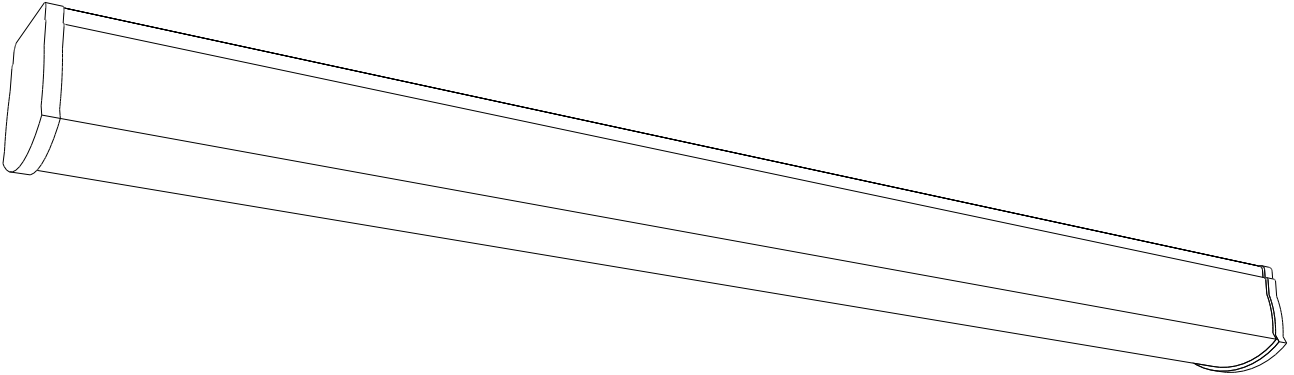

SIVA ÜSTÜ MONTAJ TİPİ - TEKLİ KLİPS / SURFACE MOUNTING TYPE - SINGLE CLIP

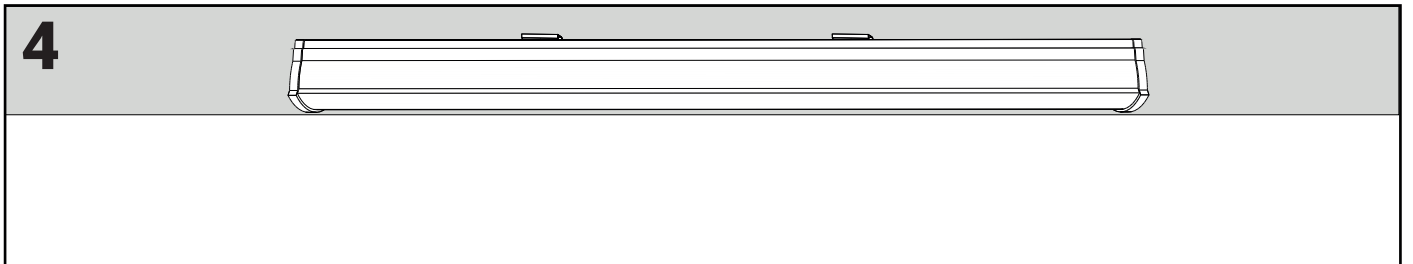
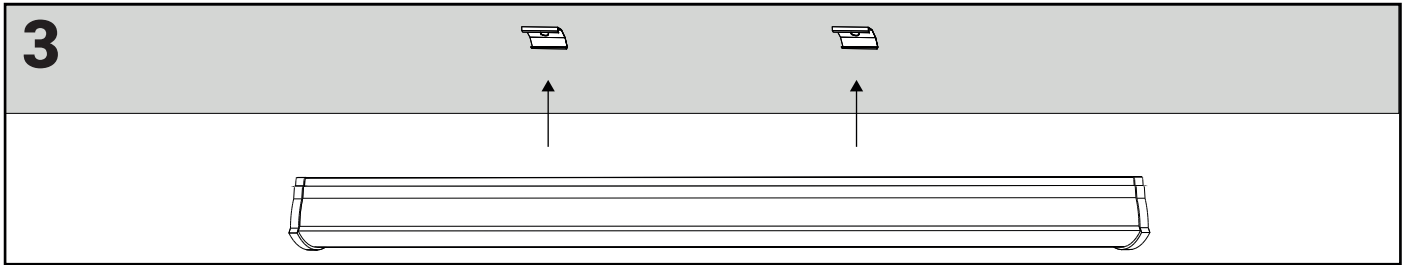
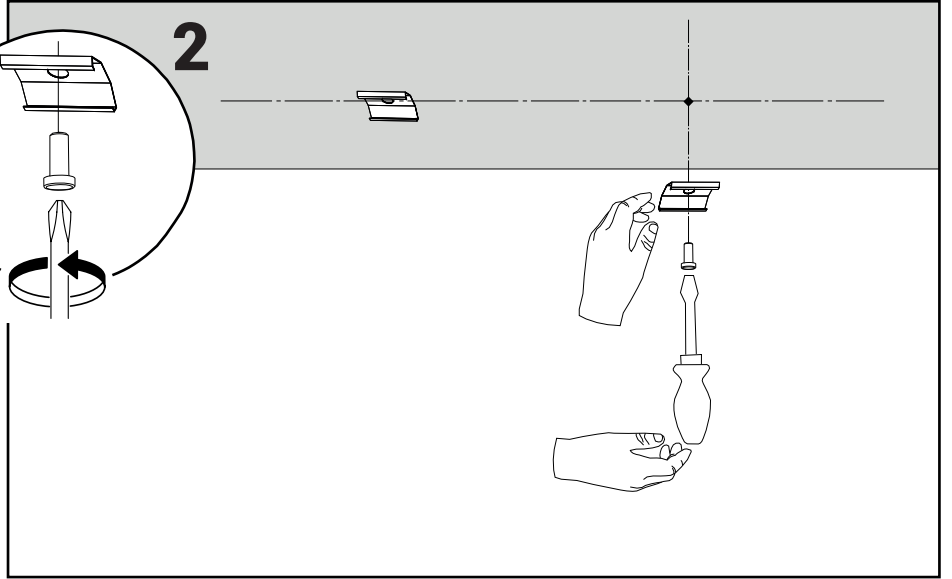
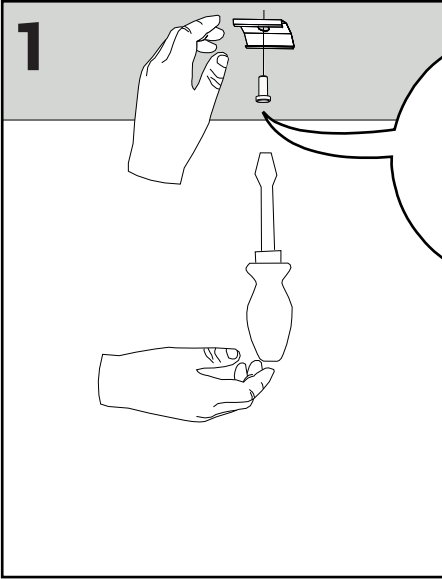
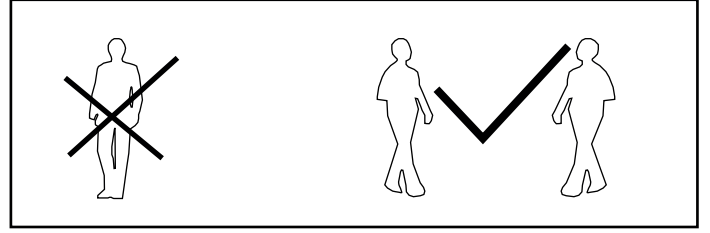
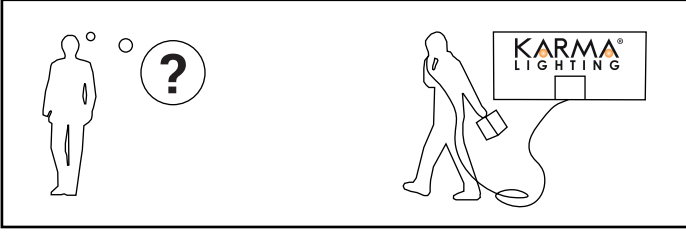

SIVA ÜSTÜ MONTAJ TİPİ - ASKI TELLİ / SURFACE MOUNTING TYPE - SUSPENDED HIRE _____

